

Shenzhen Shengyang Musical Instruments Technology Co., Ltd.



SUNRISE MELODY

M3 Electronic Wind Instrument Manual



Contents

Panel introduction-----	1
Detailed introduction of functions-----	2
Preparing to play-----	4
Connect external devices-----	5
Correct posture-----	5
Charging method-----	6
Bluetooth connection-----	6
Treble and bass control method-----	7
Four fingering charts-----	8
Timbre table-----	12
Must read for users-----	13
Troubleshooting-----	14
Product parameters-----	14

Panel introduction

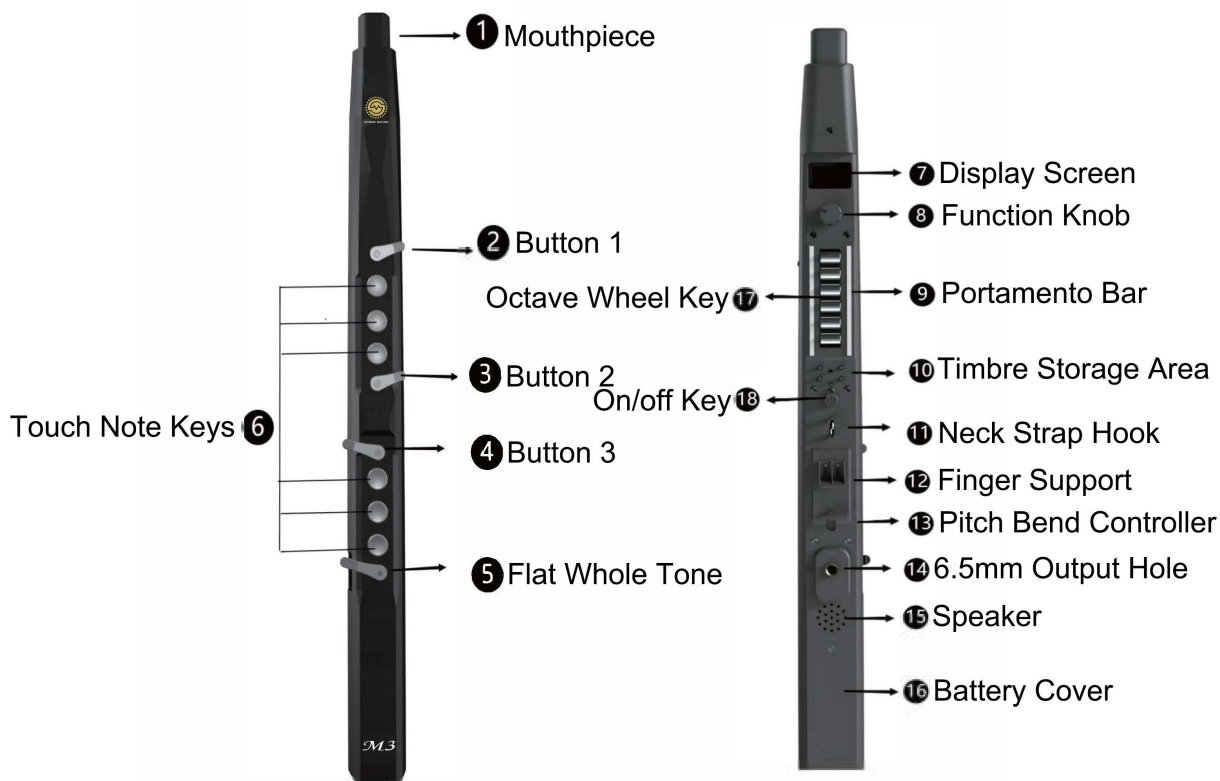

- | | |
|-------------------------|----------------------------|
| 1. Mouthpiece | 11. Neck strap hook |
| 2. Button 1 | 12. Finger support |
| 3. Button 2 | 13. Pitch bend controller |
| 4. Button 3 | 14. 6.5mm output hole |
| 5. Flat whole tone | 15. Speaker |
| 6. Touch note keys | 16. Battery cover |
| 7. Display screen | 17. Octave wheel key |
| 8. Function knob | 18. On/off key |
| 9. Portamento bar | 19. Type C charging hole |
| 10. Timbre storage area | 20. 3.5mm headphone output |

Detailed introduction of functions

1. Mouthpiece

Made of silicone, hygienic and safe. Easy to replace and clean. There is a vibrato sensor inside the mouthpiece. When you bite the mouthpiece slightly hard and hold it down while playing, a uniform vibrato will be produced.

2. Button 1 (Technique \ Sharp semitone \ Flat semitone \ Vibrato \ Instant tone change \ Instant timbre change).

You can use the function rotary key to enter the button 1 to adjust and switch the above functions.

A. Technique: When switching to the technique function, you can achieve one-key wheel fingering and one-key flutter tongue.

B. Sharp semitone: When switching to the semitone sharp function, the semitone sharp function can be realized.

C. Flat semitone: When switching to the flat semitone function, the flat semitone function can be realized.

D. Vibrato: When switching to the vibrato function, semi-automatic vibrato can be achieved (this can only be achieved by adjusting the biting vibrato mode)

E. Instant timbre change: When switching to the Instant timbre change, Instant timbre change can be achieved.

F. Instant tone change: When switching to the second pitch change function, Instant tone change can be achieved.

3. Button 2 (Technique \ Sharp semitone \ Flat semitone \ Vibrato \ Instant tone change \ Instant timbre change) see button 1 (button 1, button 2, and button 3 can be used in combination).

4. Button 3 (Technique \ Sharp semitone \ Flat semitone \ Vibrato \ Instant tone change \ Instant timbre change) see button 1 (button 1, button 2, and button 3 can be used in combination).

5. Flat whole tone

Touching this key will lower the whole tone. For example, if the 3rd tone is touched, it will become 2.

6. Touch note keys

The touch-type note keys are responsive. When your hand touches the corresponding note key, the corresponding sound will be emitted.

7. Display screen

Displays the battery power and the parameters, timbre, tonality, etc. during adjustment, making it easy to view during adjustment.

8. Function knob

The default on the screen is timbre switching (rotate left and right). Press the function button to rotate left and right to switch timbre, volume, transposition, fingering, vibrato rate, vibrato amplitude, blowing force, portamento rate, reverberation adjustment, left and right hands, and octave speed, note speed, flutter tongue speed, vibrato parameters, portamento settings, key 1, key 2, key 3 and other parameter settings. After selecting, press the function key to enter parameter adjustment. To return to the previous menu, long press the function key for 2 seconds.

Timbre adjustment: Rotate left and right to freely select your favorite timbre. There are 66 types in total.

Volume adjustment: volume range 01-100, the larger the number, the greater the volume.

Transposition adjustment: Rotate to select the desired transposition. When a negative number appears in the transposition, it means that the same octave wheel is directly lowered by one octave. The 12 transposition rotations switch.

Fingering adjustments: Flute fingering, Electric flute fingering, Electric saxophone fingering, Cucurbit flute fingering. Four fingering methods can be switched freely.

Left and right hand adjustment: left hand on top, right hand on top, rotate and switch freely.

Vibrato rate: 01-100. The larger the number, the faster the vibrato speed, and vice versa.

Vibrato amplitude: 01-100. The larger the number, the more obvious the vibrato will be, and vice versa, the less obvious it will be.

Vibrato settings: Adjustable automatic vibrato and bite vibrato switching (in this mode, semi-automatic vibrato can be achieved through button 1, button 2, and button 3, three vibrato modes)

Flutter tongue speed: 01-100. The larger the number, the faster the flutter tongue speed is, and vice versa.

Portamento rate: 01-100. The larger the number, the faster the portamento, and vice versa.

Portamento settings: equal velocity, equal time, rotate the function key left or right to switch.

Button 1: By rotating the function key, set the switching function (Technique \ Sharp semitone \ Flat semitone \ Vibrato \ Instant tone change \ Instant timbre change)

Button 2: By rotating the function key, set the switching function (Technique \ Sharp semitone \ Flat semitone \ Vibrato \ Instant tone change \ Instant timbre change)

Button 3: By rotating the function key, set the switching function (Technique \ Sharp semitone \ Flat semitone \ Vibrato \ Instant tone change \ Instant timbre change)

Reverberation adjustment: The larger the number 01-100, the greater the reverberation, and vice versa, the less obvious the reverberation will be.

Blowing force adjustment: 01-100, the larger the number, the less force required to play. When the number exceeds 60, a self-chirping will appear.

Octave speed: 01-100 The larger the number, the more sensitive the button will be, and vice versa, the less obvious it will be.

Note speed: 01-100. The larger the number, the more sensitive the key will be, and vice versa, the less obvious it will be.

12. Finger support

Place your thumb here for balance and support.

13. Pitch bend controller

Mechanical pitch bend, press downward to produce downward bend, and slowly move upward to produce upward bend.

14. 6.5mm output hole

External devices such as speakers can be connected through this hole.

15. Speaker

Built-in 3W speaker, suitable for indoor practice.

16. Battery cover

When you open this cover, you can see the built-in large-capacity lithium battery

17. Octave wheel key

High and low bass conversion, touch wheel key (the five octaves from bottom to top are: double bass, bass, mediant, treble, double treble).

18. On/off key

Press and hold for 2 seconds to turn on and off the EWI.

19. Type C charging hole

Through direct current, you can use ordinary mobile phone charging cables or USB holes to charge it. Do not use fast charging adapters, otherwise the motherboard will be burned. The damage caused by this situation is not covered by the free warranty.

20. 3.5mm headphone output

You can insert headphones through this output hole, or connect audio or tuning equipment. After connecting to this hole, the speaker will automatically turn off.

Preparing to play

1. Press and hold the power button for 2 seconds to turn on the phone.

2. Hang the neck strap on the hook, hang the other end around your neck, and tighten it.

3. Adjust the setting parameters to the appropriate position

For example: volume 75, blowing power 50, etc. Appropriate parameters have been set at the factory and can be adjusted later according to your own preferences.

4. Choose the fingering method that suits you, choose the timbre you like, and then you can play the songs you like.

5. Place the mouthpiece between the lips and teeth. There is a bite vibrato piece inside the mouthpiece. When using the bite vibrato, biting it will produce a vibrato effect.

Connect external devices

Connect speakers

6.5mm audio output hole

Through this audio output hole, a 6.5mm frequency cable or wireless transceiver can be used to connect the speaker.



Connect headphones

3.5mm audio output hole

Headphones can be inserted through the 3.5mm audio output hole. At this time, there is no sound from the built-in speaker.

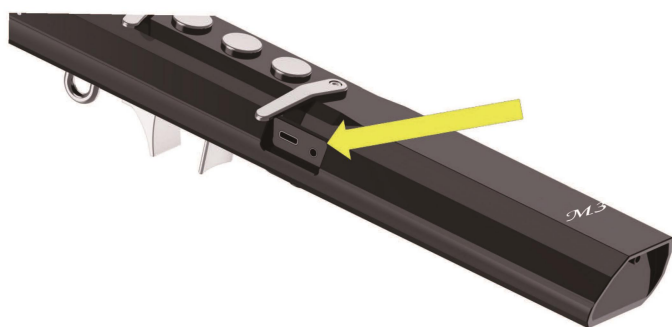

Correct posture

Beginners should try to use the neck strap, tighten the neck strap, put the weight on the neck strap, relax your hands, and place the instrument directly in front of the body, with the left hand on top and the right hand on the bottom. Backhand players can choose a backhand setting with right hand on top and left hand on bottom.



Charging method

The charging port is on the side of the EWI and has a built-in battery. Insert the charging cable into the charging hole. There will be a red light indicator when charging. The screen power grade will change and turn green when it is full. The screen power grade will stop changing and there is charging protection. You can charge with peace of mind before going to bed. There is a power display in the upper right corner of the screen when charging. When the battery shows the last bar, charge it fast. Do not use it during charging. It will automatically shut down when the battery is too low.

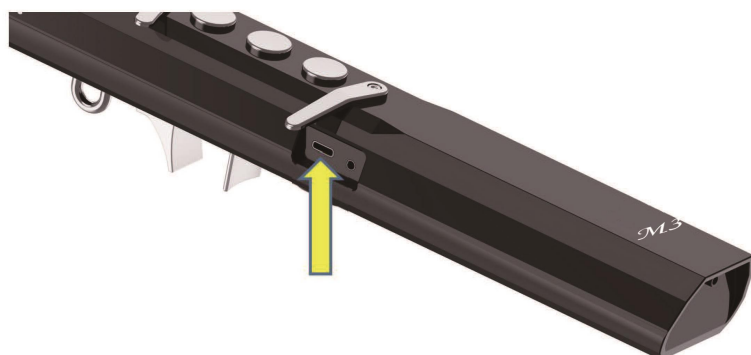

Bluetooth connection

The Bluetooth of the EWI is turned on by default. Turn on Bluetooth on your mobile phone or music score reader, search for the Bluetooth name M3_BT and click pairing. After successful pairing, the Bluetooth symbol will be displayed on the screen of the EWI.

Treble and bass control method

When playing, the thumb should be placed in the gap between the two keys. When the thumb is not pressing all the keys, the blowpipe will sound in a medium tone.



倍高音 Double treble

高音 Treble

中音 Mediant

低音 Bass

倍低音 Double bass

Four fingering charts

Flute fingering

1 do



2 re

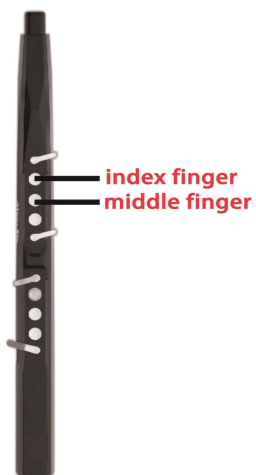

3 mi



4 fa



5 sol



6 la

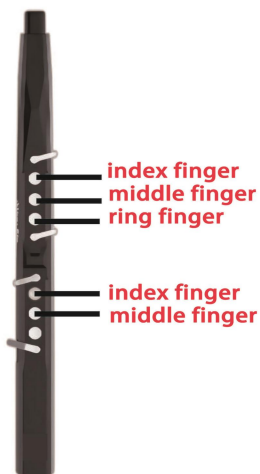

7 si

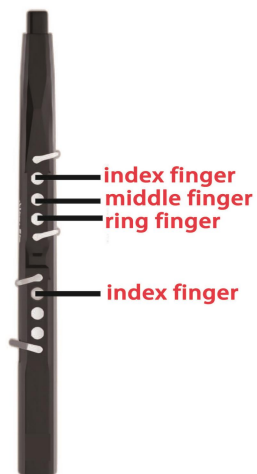

[•]
1 do



Electric flute fingering

1 do

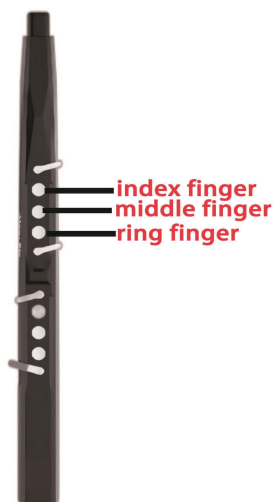

2 re

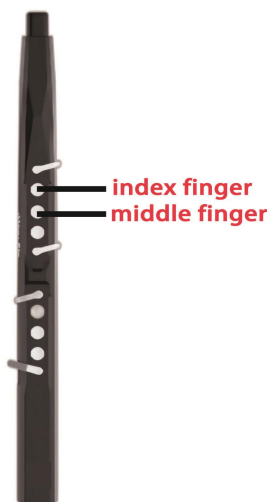

3 mi



4 fa



5 sol

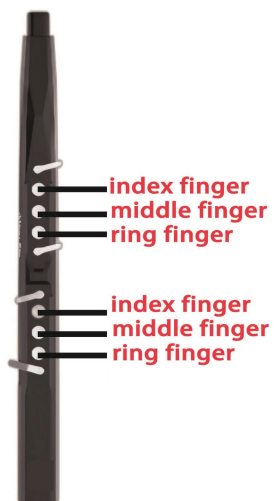

6 la

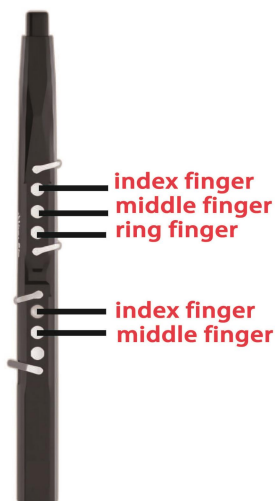

7 si

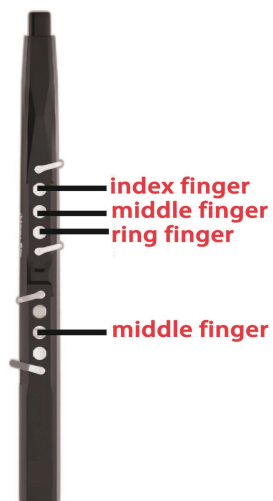

$\dot{1}$ do



Electric saxophone fingering

1 do

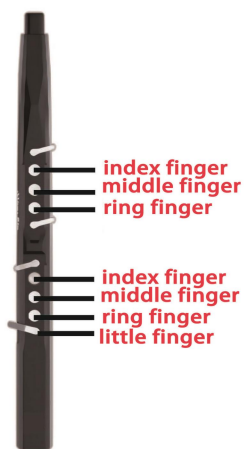

2 re

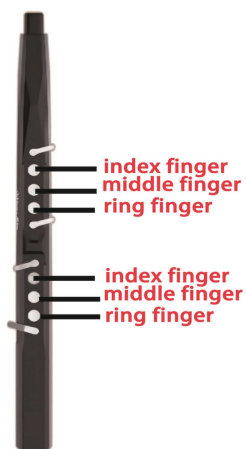

3 mi

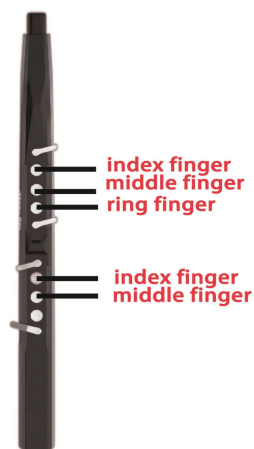

4 fa



5 sol

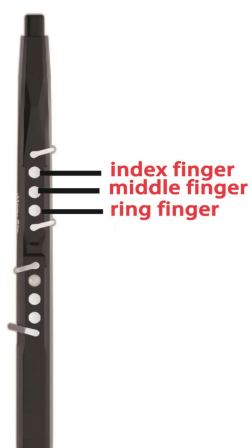

6 la

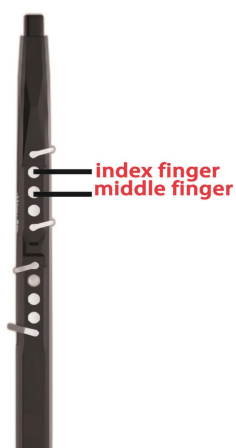

7 si



[•]
1 do



Cucurbit flute fingering

1 do

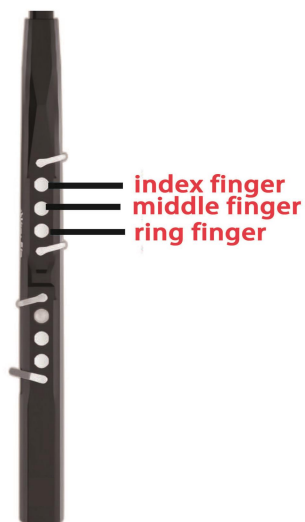

2 re

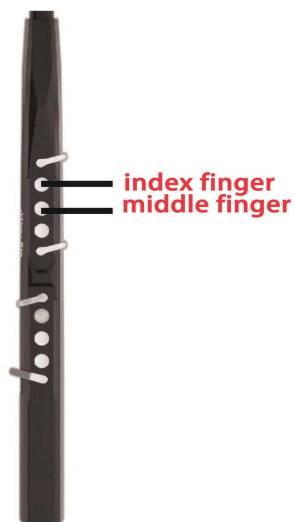

3 mi



4 fa

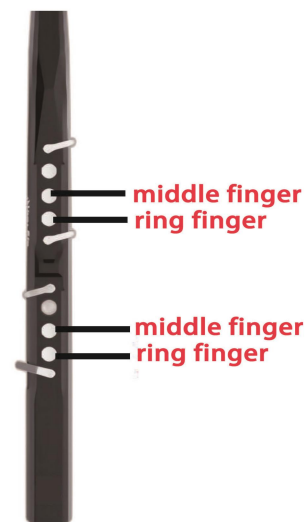

5 sol

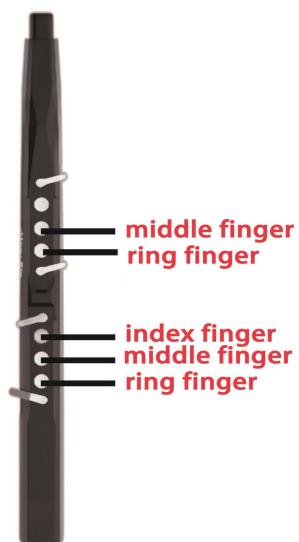

6 la

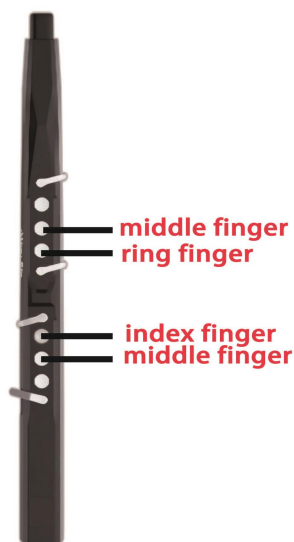

7 si

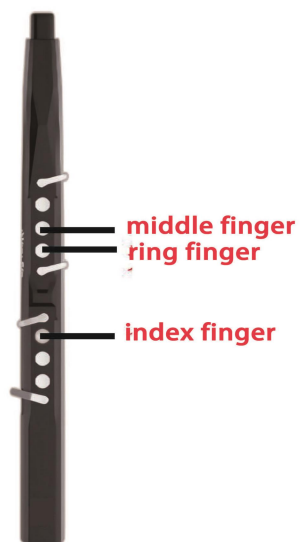

[•]1 do

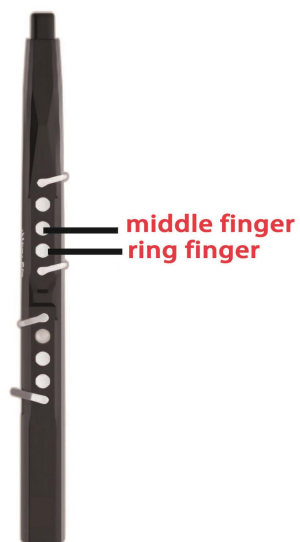

Timbre table

Serial number	Timbre	Serial number	Timbre
1	Electric flute	34	Clarinet
2	Electronic solo	35	Brass 1
3	Popular flute	36	Brass 2
4	Bamboo flute	37	Brass 3
5	Vibrato flute	38	Trombone
6	Xun	39	Bass strings
7	Pan flute	40	Fifth space
8	Pipa	41	Piano
9	Erhu	42	Electronic string
10	Morin khuur	43	Crystal piano
11	Suona	44	Church organ
12	Bells	45	Bottle blow
13	Soft alto saxophone	46	Recorder
14	Alto saxophone	47	Synthesizer
15	Soprano saxophone	48	Oboe
16	Tenor saxophone	49	British tube
17	Saxophone	50	Electric Organ
18	Trumpet	51	Popular trumpet
19	Harmonica	52	Organ 1
20	French horn	53	Organ 2
21	Synthetic bass	54	National viola
22	Electronic music 1	55	Cello
23	Electronic music 2	56	Okarena
24	Violin	57	Contrabass
25	Harmonium	58	Piccolo
26	Viola	59	Flute
27	Cucurbit flute	60	Guitar
28	Accordion	61	Celesta
29	Chinese zither	62	Wind unison
30	Vertical flute	63	Timpani
31	Sheng	64	Malimba
32	Shakuhachi	65	Electronic square wave
33	Drum kit	66	Sawtooth wave

Must read for users

1. Keep it dry: If saliva, sweat or other liquids flow outside the tube and are not cleaned in time, the liquid will enter the tube from the gaps or outer screens outside the tube, causing internal circuit failure. This failure is not covered by the warranty.
2. If the equipment fails, please do not disassemble or modify it without permission, otherwise you will not enjoy the warranty service within the warranty period.
3. Wipe it with a soft cloth or cotton towel after use to prevent sweat from corroding the keys.
4. Avoid falling and bumping. The electric blow torch is an electronic product with a plastic shell on the surface and is not drop-resistant. After use, put the hair dryer in the bag or stand it upright to avoid falling and breaking it.
5. Prevent the instrument from falling into water or other liquids. If it does, shut it down immediately. Repairs caused by humans are not covered by the warranty.
6. In humid weather, moisture-proof treatment should be done and placed in the bag after use. You can put some desiccant in the bag.
7. Rinse your mouth after eating before playing to avoid clogging the pipes.
8. Keep your fingers as clean as possible and do not play when there is water or sweat.
9. If there is too much saliva when playing, it may be that the mouthpiece is held too deep or the way of pronouncing the sound is wrong.
10. Avoid shaking the EWI with force, which will cause the water inlet of the sensor and the built-in parts to loosen.
11. If it is not used for a long time, it can be charged frequently. Prevent the battery from being unusable due to power loss.
12. Don't wait until the battery is completely empty before charging. Frequent power loss will affect the battery life. When charging, you cannot use mobile phone fast charging adapters to charge, use the configured cable to charge.
13. To replace the mouthpiece, first unscrew the fixing screw. Do not shake it hard when pulling it out to prevent the bite plate from being broken.
14. High temperature protection: Do not place this product in high temperature, fire, sunlight or battery-disturbed environment.

Troubleshooting

1. Can't turn on the EWI

You can try removing the battery and plugging it in again, if it still doesn't turn on. Please contact after-sales customer service.

2. Out of tune

You can power off and restart. If the pitch is still inaccurate after restarting, please pay attention to observe whether the semitone keys are touching each other. If there are no problems with these, it is generally a problem with the fingering selection.

3. Self-chirping

Turn knob 2, and the value should not exceed 60. If the number is lower than 60 and it still self-chirping, please leave it for a while and wait for the saliva to dry.

4. The method to deal with the instrument that does not sound or the sound is small is as follows:

(1) Click the knob, find the volume setting, and increase the volume.

(2) Click the knob to find the blowing force setting. Increase the blowing force but not exceed 60.

(3) Check whether there are plugs inserted into the 6.5mm jack and 3.5mm jack. If so, please unplug them.

(4) Check whether the external speaker is connected well and whether the speaker volume is adjusted to the optimal position.

(5) If there is a problem with the settings, please restore the factory settings. (Press and hold the rotation function key and the No. 1 storage key at the same time)

Product parameters

Model: M3

Timbre: 66 types

Mouthpiece: silicone material

Tonality: 12

Speaker: 3W

Material: environmentally friendly plastic material

Battery: 3.7V 2600mAh

Weight: 500g

Display: LCD display

Size: 52*57*56mm

Interface: 3.5 headphone audio port, 6.5 audio output port, TYPE-C charging hole